

NCP1526

400 mA, 1.2 V, High-Efficiency, Step-Down Converter with Low Noise Voltage Regulator Optimized for RF Module

The NCP1526 product is a monolithic integrated circuit combining step-down PWM DC-DC converter dedicated to the portable applications powered from one cell Li-ion or three cell Alkaline/NiCd/NiMH batteries and a low noise output voltage regulator dedicated to supply RF sensitive module in the portable applications.

The DC-DC converter operates with a fixed output voltage of 1.2 V and delivers up to 400 mA. It uses synchronous rectification to increase efficiency and reduces external part count. The device also has a built-in 3.0 MHz (nominal) oscillator which reduces component size by allowing small inductor and capacitors. It includes an integrated soft-start, cycle-by-cycle current limiting, and thermal shutdown protection.

The additional 2.80 V very low noise, low drop output regulator, is available with 150 mA current capability, current limitation and overtemperature protection.

Finally, the NCP1526 is available in a space saving, ultra low profile 3x3 mm 10 pin UDFN package (thickness 0.55 mm max).

Features

- Step-Down Converter
 - Up to 85% Efficiency
 - Output Current Capability 400 mA
 - 3.0 MHz Switching Frequency
 - 1.2 V Fixed Output Voltage
 - Synchronous Rectification for Higher Efficiency
- LDO Regulator
 - 2.80 V Output Voltage
 - Up to 150 mA Output Current Capability
 - Very Low Noise: 45 μ V_{RMS}
- All Pins are Fully ESD Protected
- 2.7 V to 5.5 V Input Voltage Range
- Thermal Limit Protection
- 3.0 mm x 3.0 mm x 0.55 mm UDFN Package
- This is a Pb-Free Device

Typical Applications

- Cellular Phones, Smart Phones and PDAs
- Digital Still Cameras
- MP3 Players and Portable Audio Systems
- Wireless and DSL Modems
- Portable Equipment



ON Semiconductor®

<http://onsemi.com>



10 PIN DFN
MU SUFFIX
CASE 506AT

MARKING DIAGRAM

1526
ALYW▪

1526 = Specific Device Code
A = Assembly Location
L = Wafer Lot
Y = Year
W = Work Week
▪ = Pb-Free Package

(Note: Microdot may be in either location)

PIN CONNECTIONS

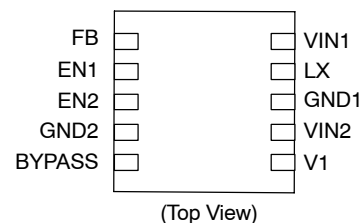

ORDERING INFORMATION

Device	Package	Shipping†
NCP1526MUTXG	UDFN-10 (Pb-Free)	3000/Tape & Reel

†For information on tape and reel specifications, including part orientation and tape sizes, please refer to our Tape and Reel Packaging Specification Brochure, BRD8011/D.

NCP1526

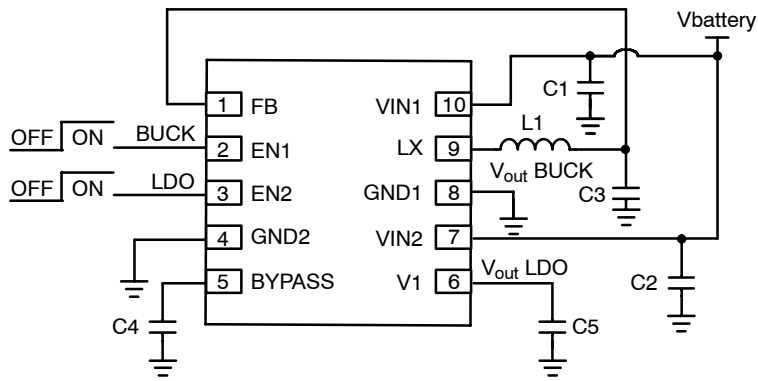

Figure 1. Typical Applications Circuit

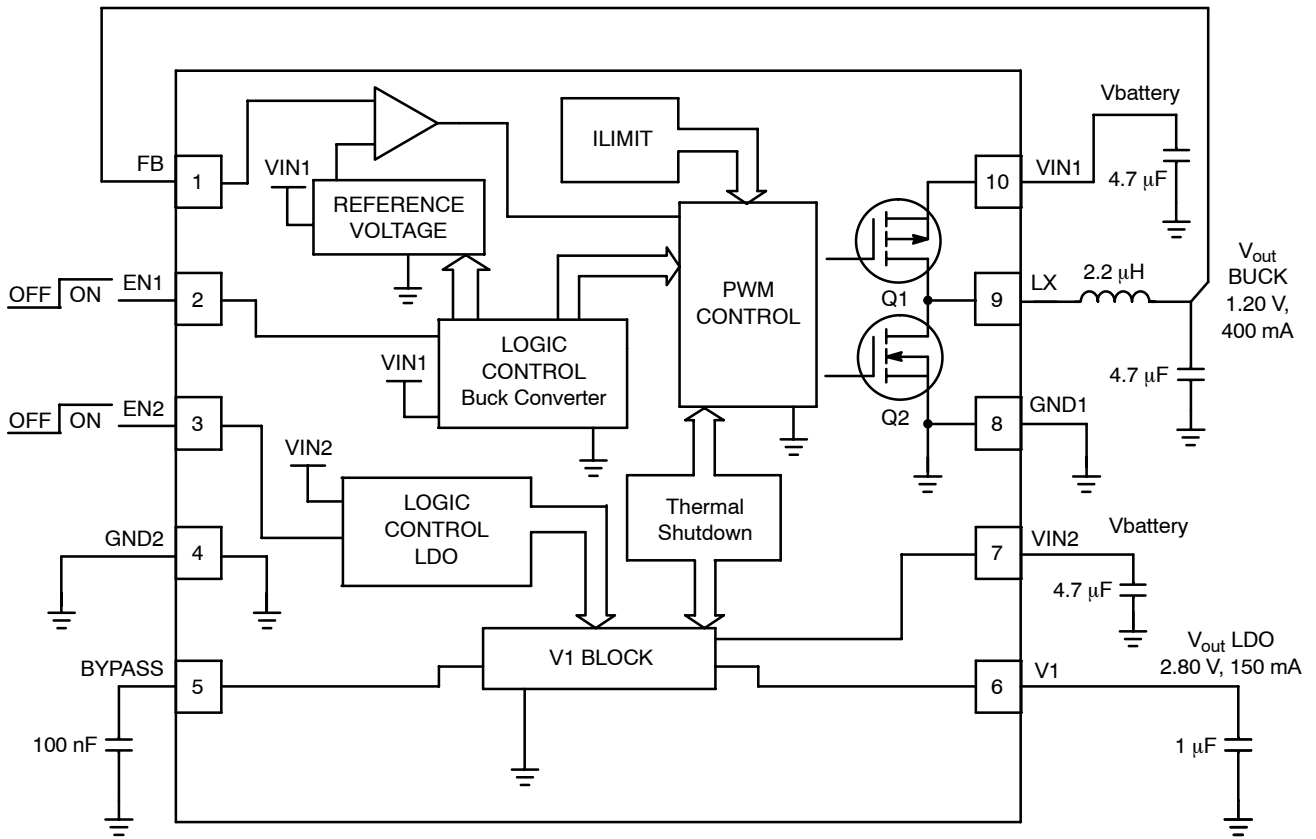

Figure 2. Simplified Block Diagram

NCP1526

PIN FUNCTION DESCRIPTION (Pin out provided for concept purpose only and might change in the final product.)

Pin No.	Symbol	Function	Description
1	FB	Analog Input	Feedback voltage from the output of the power supply. This is the input to the error amplifier.
2	EN1	Digital Input	Enable for DC-DC converter. This pin is active high. It is turned off by logic LOW on this pin. Do not float this pin.
3	EN2	Digital Input	EN2 enables the LDO. A HIGH level on this pin activates the voltage regulator. It is turned off by logic LOW on this pin. Do not float this pin.
4	GND2	Power Ground	Ground connection for the LDO section and must be connected to the system ground.
5	BYPASS		Bypass is the bandgap reference for the LDO. This pin requires a 100 nF bypass capacitor for low noise. This pin cannot be used for an external source.
6	V1	Output Power	This pin provides the output voltage supplied by the LDO. This pin requires 1.0 μ F decoupling capacitor.
7	VIN2	Power Input	Input battery voltage to supply voltage regulator blocks. The pin requires a 4.7 μ F decoupling capacitor.
8	GND1	Power Ground	This pin is the GROUND reference for the DC-DC converter and the output control. The pin must be connected to the system ground.
9	LX	Analog Output	Connection from Power MOSFETs to the inductor. An output discharge circuit sinks current from this pin.
10	VIN1	Power Input	Input battery voltage to supply the analog and digital blocks of the DC-DC converter. The pin must be decoupled to ground by a 4.7 μ F ceramic capacitor.

MAXIMUM RATINGS

Rating	Symbol	Value	Unit
Minimum Voltage All Pins	V_{min}	-0.3	V
Maximum Voltage All Pins (Note 2)	V_{max}	7.0	V
Maximum Voltage EN1, EN2, FB, LX	V_{max}	VIN + 0.3	V
UDFN10 Package (Note 5) Thermal Resistance, Junction-to-Air	$R_{\theta JA}$	240	$^{\circ}$ C/W
Operating Ambient Temperature Range	T_A	-40 to 85	$^{\circ}$ C
Storage Temperature Range	T_{stg}	-55 to 150	$^{\circ}$ C
Junction Operating Temperature	T_J	-40 to 125	$^{\circ}$ C
Latch-up Current Maximum Rating ($T_A = 85^{\circ}$ C) (Note 4) FB pin Other pins	I_{Lu}	± 70 ± 100	mA
ESD Withstand Voltage (Note 3) Human Body Model Machine Model	V_{esd}	2.0 200	kV V

Maximum ratings are those values beyond which device damage can occur. Maximum ratings applied to the device are individual stress limit values (not normal operating conditions) and are not valid simultaneously. If these limits are exceeded, device functional operation is not implied, damage may occur and reliability may be affected.

- Maximum electrical ratings are defined as those values beyond which damage to the device may occur at $T_A = 25^{\circ}$ C.
- According to JEDEC standard JESD22-A108B.
- This device series contains ESD protection and exceeds the following tests:
Human Body Model (HBM) per JEDEC standard: JESD22-A114.
Machine Model (MM) per JEDEC standard: JESD22-A115.
- Latchup current maximum rating per JEDEC standard: JESD78.
- The exposed flag shall be connected to ground.
- Moisture Sensitivity Level (MSL): 1 per IPC/JEDEC standard: J-STD-020A.

NCP1526

ELECTRICAL CHARACTERISTICS, DC/DC Converter (Typical values are referenced to $T_A = +25^\circ\text{C}$, Min and Max values are referenced -40°C to $+85^\circ\text{C}$ ambient temperature, unless otherwise noted, operating conditions $V_{IN} = 3.6\text{ V}$, unless otherwise noted.)

Characteristic	Pin	Symbol	Min	Typ	Max	Unit
----------------	-----	--------	-----	-----	-----	------

VIN1 PIN

Input Voltage Range	10	V_{in}	2.7	–	5.2	V
Quiescent Current, $I_{out} = 0\text{ mA}$, No Switching	8	$I_{q\text{ ON}}$	–	250	350	μA
Quiescent Current, $I_{out} = 0\text{ mA}$, Oscillator Running			–	550	–	
Quiescent Current, EN Low	8	$I_{q\text{ OFF}}$	–	0.2	1.5	μA
Undervoltage Lockout (V_{IN} Increase)	10	V_{UVLO}	–	2.5	–	V
Undervoltage Lockout Hysteresis	10	V_{HUVLO}	–	100	–	mV

EN1, EN2 PIN

Positive Going Input High Voltage Threshold, EN0 Signal	2, 3	V_{IH}	1.2	–	–	V
Negative Going Input High Voltage Threshold, EN0 Signal	2, 3	V_{IL}	–	–	0.4	V

DC-DC CONVERTER SECTION

Peak Inductor Current	9	I_{LIM}	–	1000	–	mA
Feedback Voltage Threshold	1	V_{FB}	1.164	1.2	1.236	V
Overtemperature						
Load Transient Response, Rise/Fall Time $1.0\ \mu\text{s}$	–	V_{OUT}	–	30	–	mV
1.0 mA to 300 mA Load Step			–	35	–	
1.0 mA to 400 mA Load Step			–	–	–	
Line Transient Response, $I_{out} = 100\text{ mA}$, 3.0 V to 3.6 V Line Step	–	V_{OUT}	–	± 5.0	–	mVpp
Output Voltage Load Regulation	–	V_{OUT}	–	0.2	–	%
$I_{out} = 1.0\text{ mA}$ to 300 mA			–	0.5	–	
$I_{out} = 1.0\text{ mA}$ to 400 mA			–	–	–	
Output Voltage Line Regulation, $I_{out} = 100\text{ mA}$, $V_{IN} = 2.7\text{ V}$ to 5.2 V	–	V_{OUT}	–	0.1	–	%
Output Voltage Ripple, $I_{out} = 300\text{ mA}$	–	V_{OUT}	–	5.0	–	mV
Oscillator Frequency	9	F_{OSC}	2.4	3.0	3.6	MHz
P-Ch On-Resistance	1	$RLxH$	–	400	–	$\text{m}\Omega$
N-Ch On-Resistance	1	$RLxL$	–	400	–	$\text{m}\Omega$
P-Ch Leakage Current	1	I_{LeakH}	–	0.05	–	μA
N-Ch Leakage Current	1	I_{LeakL}	–	0.01	–	μA
Soft-Start Time	–	T_{start}	–	100	300	μs

NCP1526

ELECTRICAL CHARACTERISTICS for LDO (Typical values are referenced to $T_A = +25^\circ\text{C}$, Min and Max values are referenced -40°C to $+85^\circ\text{C}$ ambient temperature, unless otherwise noted, operating conditions $3\text{ V} < V_{IN} < 5.2\text{ V}$, unless otherwise noted.)

Characteristic	Pin	Symbol	Min	Typ	Max	Unit
----------------	-----	--------	-----	-----	-----	------

VIN2 PIN

Input Voltage Range	7	V_{in}	3	–	5.2	V
Quiescent Current On State $V_{IN2} = 4.2\text{ V}$, $I_{out} = 0\text{ mA}$	4	$I_{q\text{ ON}}$	–	70	95	μA
Quiescent Current Off State	4	$I_{q\text{ OFF}}$	–	0.2	–	μA

LDO SECTION

Output Voltage, $I_{out} = 0\text{ mA}$ to 150 mA	6	V1	2.716	2.80	2.884	V
Maximum Output Current	6	I_{out}	150	–	–	mA
Output Voltage Line Regulation, $I_{out} = 10\text{ mA}$	6	V1	–	10	–	mV
Load Regulation, $I_{out} = 1.0\text{ mA}$ to 150 mA , $V_{IN} = 3.6\text{ V}$	6	V1	–	20	–	mV
Power Supply Ripple Rejection on V1, (0.2 Vp-p), $C_{out} = 1.0\ \mu\text{F}$, $V_{in} = 3.6\text{ V}$ 1.0 kHz $I_{out1} = 100\ \mu\text{A}$ 100 kHz, $I_{out1} = 100\ \mu\text{A}$	6	PSRR	– –	67 45	– –	dB
Dropout Voltage, $I_{out} = 150\text{ mA}$		VINA-V1	–	–	150	mV
Output Short Circuit Current	6	ISC	250	300	–	mA
Output Noise Voltage, 100 Hz to 100 kHz, $I_{out} = 10\text{ mA}$, $C_{out} = 1.0\ \mu\text{F}$	6	V_N	–	45	–	μVrms
Turn ON Output Voltage, $V_{in} = 3.6\text{ V}$	6	Ton	–	80	150	μs

BYPASS PIN

Output Voltage, $C_{by} = 100\text{ nF}$	5	V_{BY}	–	1.5	–	V
--	---	----------	---	-----	---	---

TYPICAL CHARACTERISTICS

NCP1526 circuit on Figure 2, $V_{in} = 3.6\text{ V}$, $T_A = 25^\circ\text{C}$, unless otherwise noted

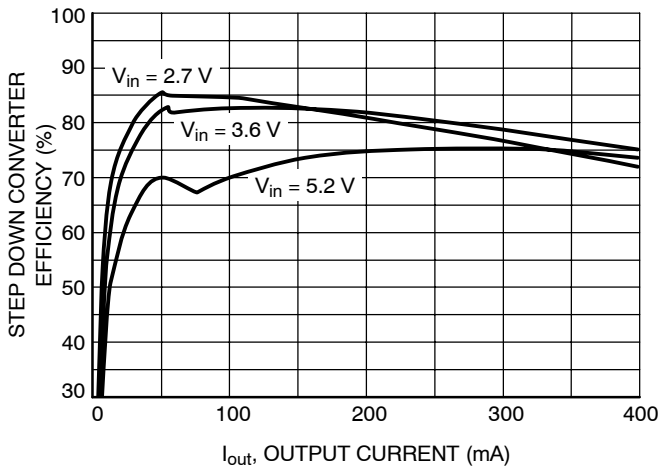

Figure 3. Step Down Converter Efficiency vs. Output Current

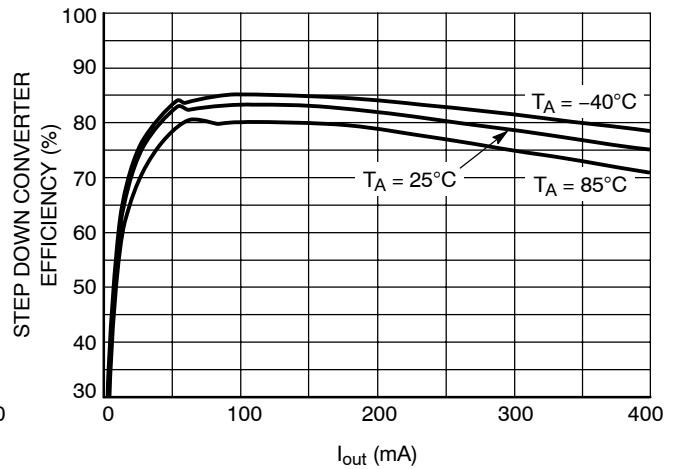

Figure 4. Step Down Converter Efficiency vs. Temperature $V_{in} = 3.6\text{ V}$

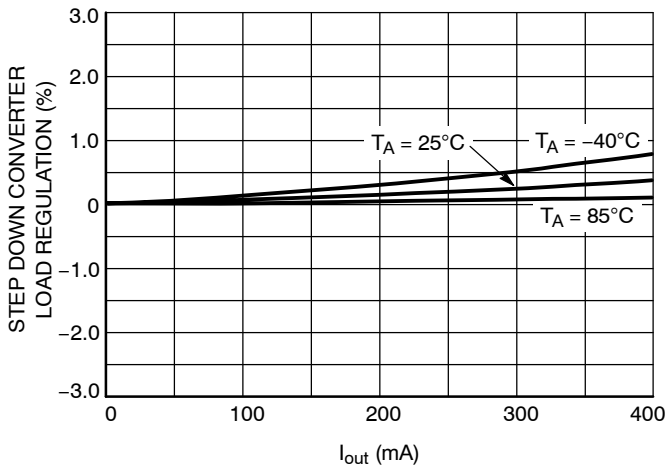

Figure 5. Step Down Converter Load Regulation vs. Temperature $V_{in} = 3.6\text{ V}$

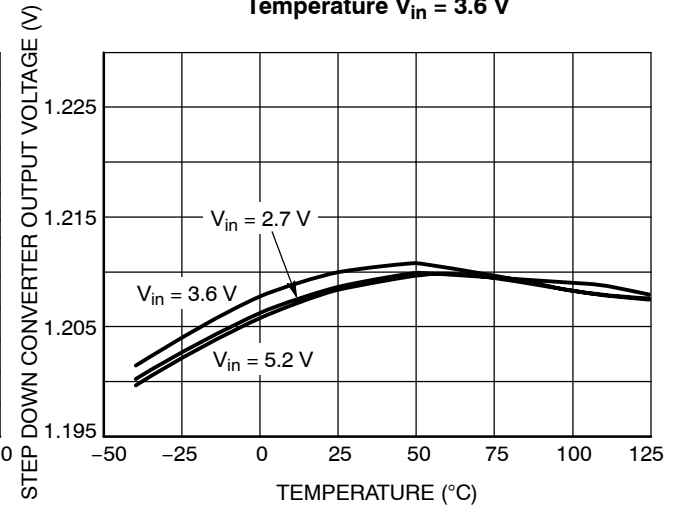

Figure 6. Step Down Converter Output Voltage vs. Temperature at $I_{out} = 100\text{ mA}$

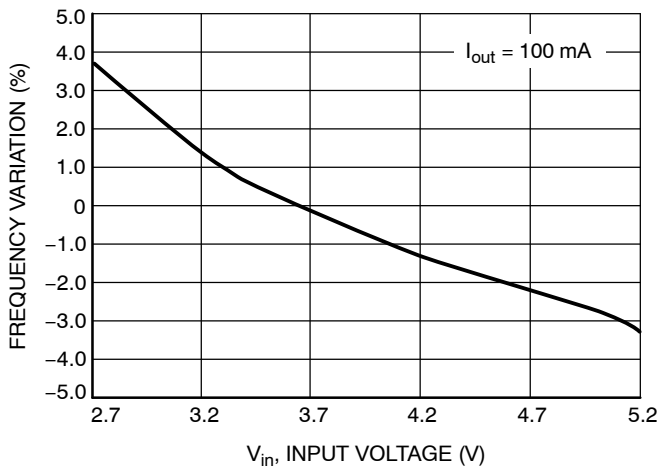

Figure 7. Step Down Converter Switching Frequency vs. Input Voltage

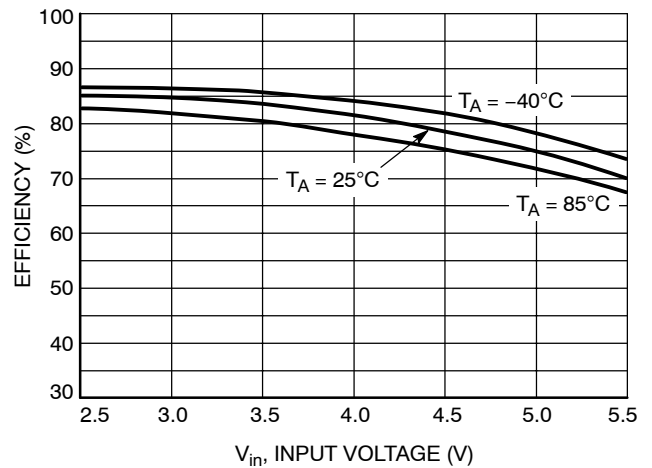

Figure 8. Step Down Converter Efficiency vs. Input Voltage at $I_{out} = 100\text{ mA}$

NCP1526

TYPICAL CHARACTERISTICS

NCP1526 circuit on Figure 2, $V_{in} = 3.6\text{ V}$, $T_A = 25^\circ\text{C}$, unless otherwise noted

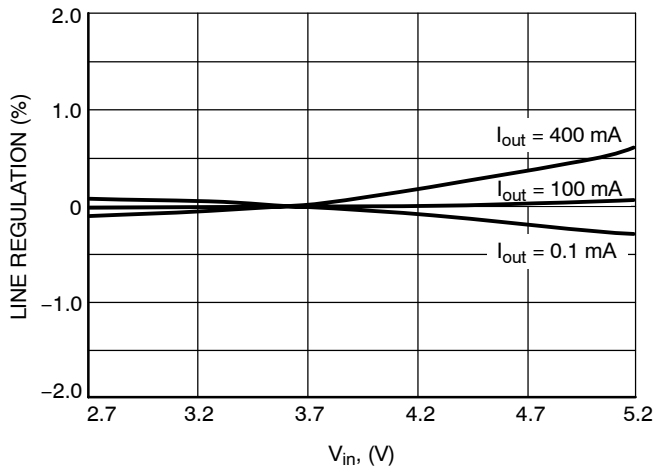

Figure 9. Step Down Converter Line Regulation vs. Output Current

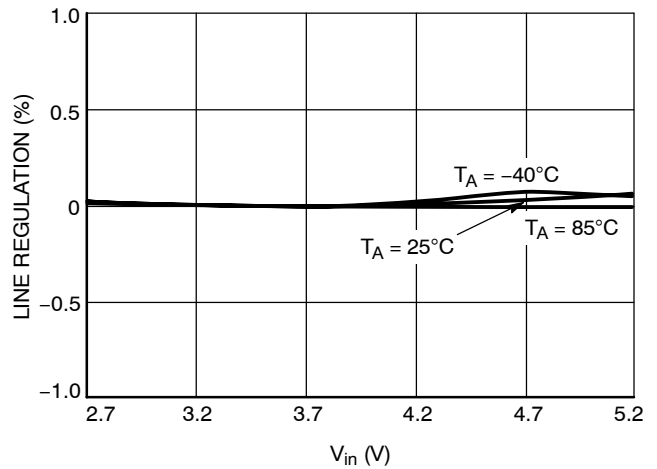

Figure 10. Step Down Converter Line Regulation vs. Temperature at $I_{out} = 100\text{ mA}$

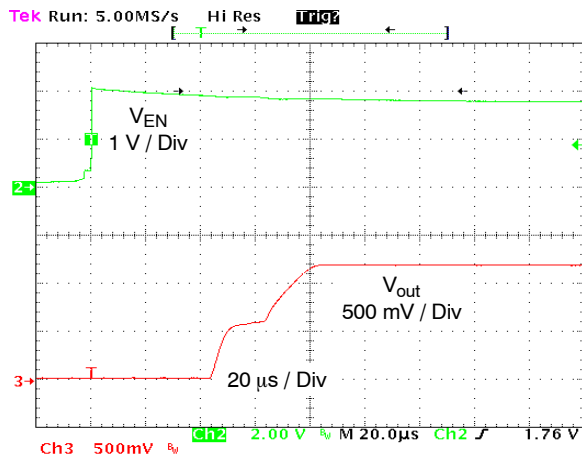

Figure 11. Step Down Converter Soft Start Time

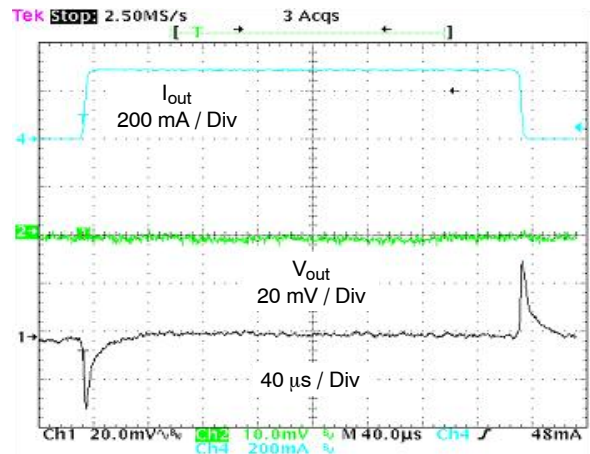

Figure 12. Step Down Converter Load Transient Response

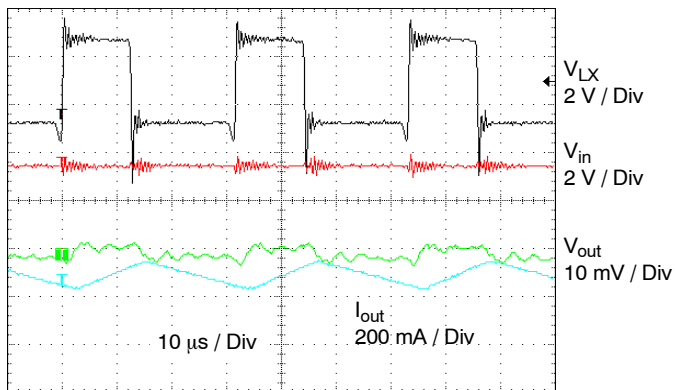

Figure 13. Step Down Converter PWM Mode of Operation

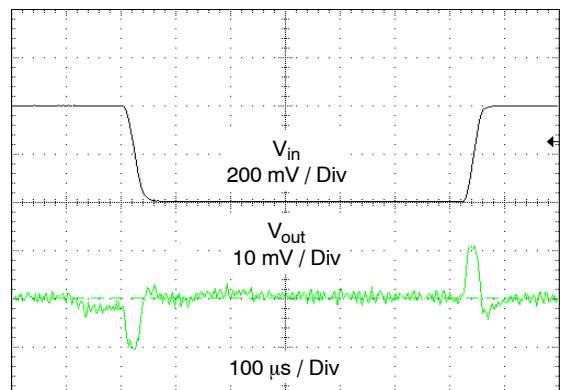

Figure 14. Step Down Converter Line Transient Response

NCP1526

TYPICAL CHARACTERISTICS

NCP1526 circuit on Figure 2, $V_{in} = 3.6\text{ V}$, $T_A = 25^\circ\text{C}$, unless otherwise noted

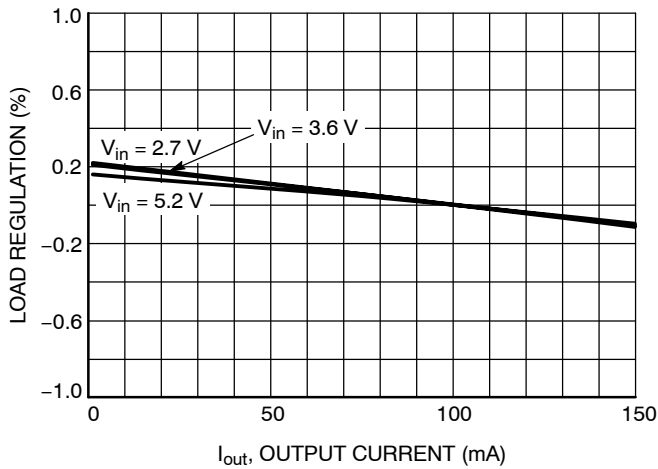

Figure 15. LDO Load Regulation

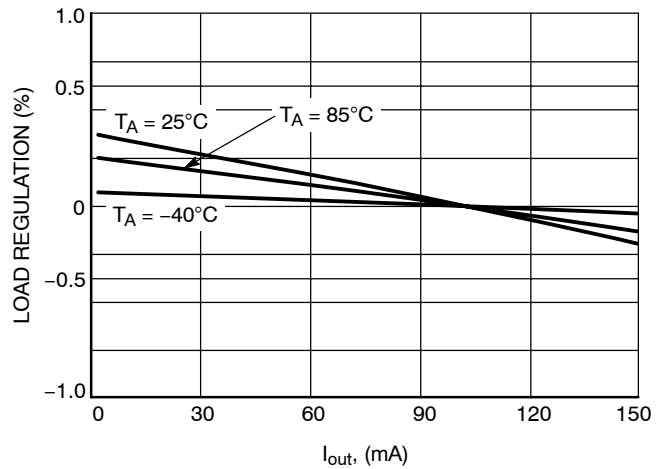

Figure 16. LDO Load Regulation vs. Temperature

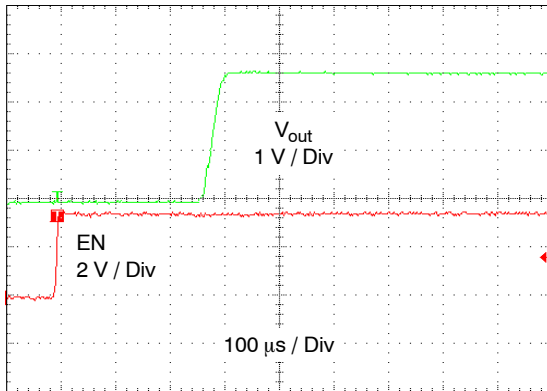

Figure 17. LDO Turn On Time from Enable

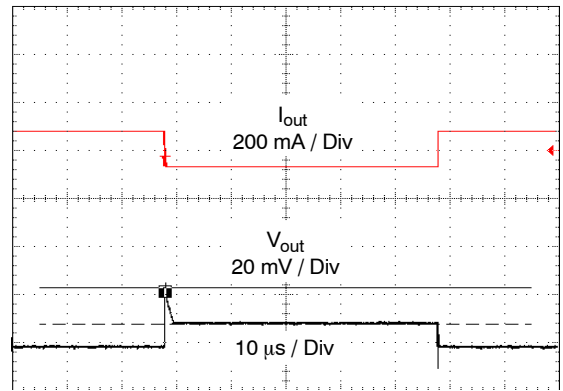

Figure 18. LDO Load Transient Response

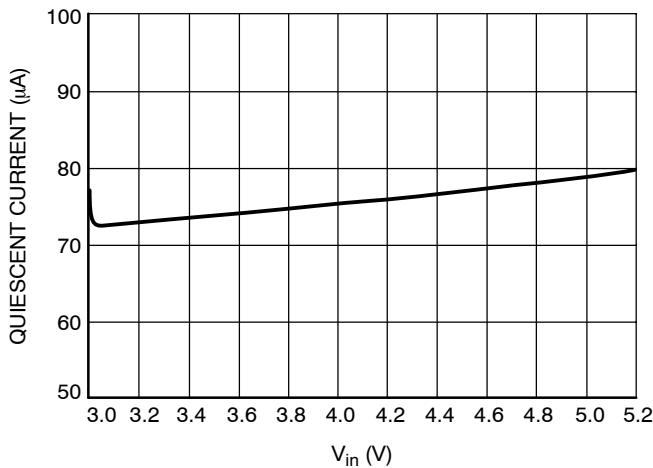

Figure 19. LDO Quiescent Current vs. Input Voltage

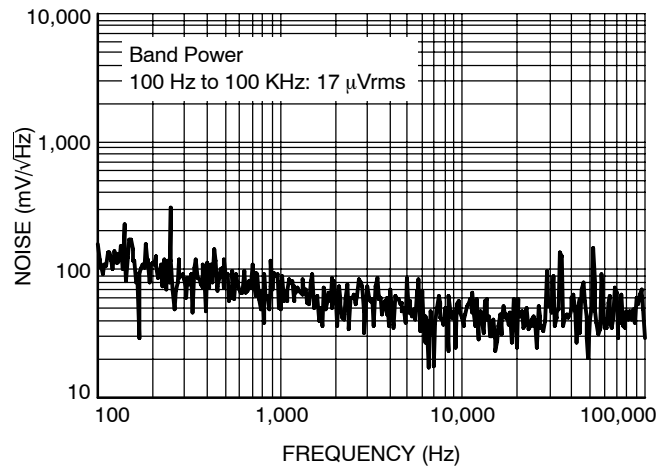

Figure 20. LDO Noise (DC/DC Converter Off)

NCP1526

TYPICAL CHARACTERISTICS

NCP1526 circuit on Figure 2, $V_{in} = 3.6\text{ V}$, $T_A = 25^\circ\text{C}$, unless otherwise noted

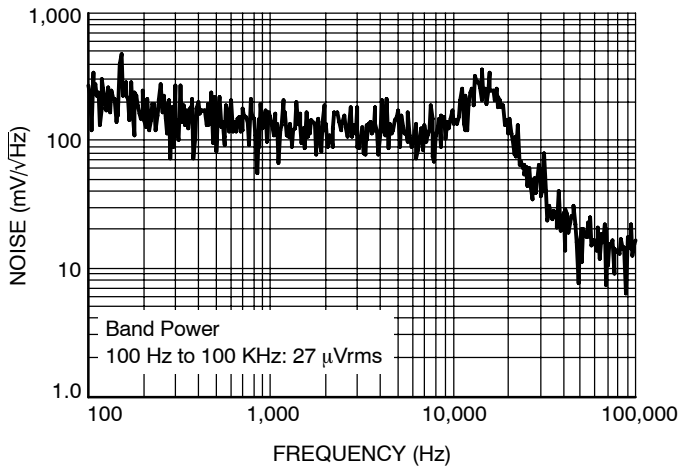

Figure 21. LDO Noise (DC/DC Converter On)

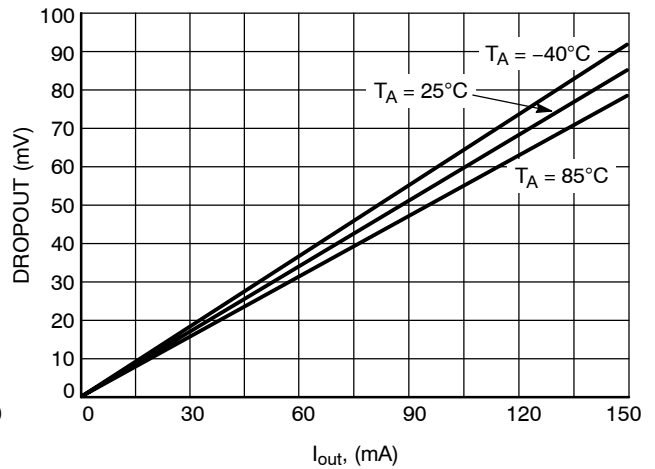

Figure 22. LDO Dropout Voltage vs. Output Current

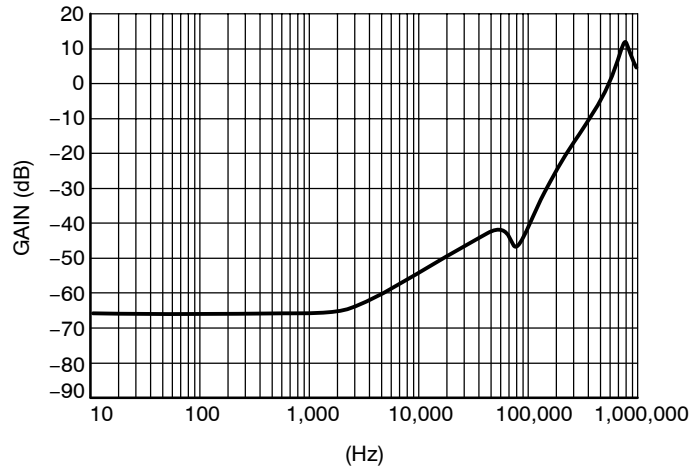

Figure 23. LDO PSRR at $I_{out} = 100\ \mu\text{A}$, $V_{in} = 3.6\text{ V}$

DC-DC OPERATION DESCRIPTION

Detailed Description

The NCP1526 uses a constant frequency, voltage mode step-down architecture. Both the main (P-Channel MOSFET) and synchronous (N-Channel MOSFET) switches are internal.

It delivers a constant voltage from either a single Li-Ion or three cell NiMH/NiCd battery to portable devices such as cell phones and PDA. The output voltage accuracy is well within 3% of the 1.20 V. The NCP1526 can source at least 400 mA.

PWM Operating Mode

The output voltage of NCP1526 is regulated by modulating the on-time pulse width of the main switch Q1

at a fixed 3.0 MHz frequency. The switching of the PMOS Q1 is controlled by a flip-flop driven by the internal oscillator and a comparator that compares the error signal from an error amplifier with the PWM ramp. At the beginning of each cycle, the main switch Q1 is turned ON by the rising edge of the internal oscillator clock. When the PWM ramp becomes higher than the error voltage amplifier the PWM comparator resets the flip-flop, Q1 is turned OFF and the synchronous switch Q2 is turned ON. Q2 replaces the external Schottky diode to reduce the conduction loss and improve the efficiency. To avoid overall power loss, a certain amount of dead time is introduced to ensure Q1 is completely turned OFF before Q2 is being turned ON.

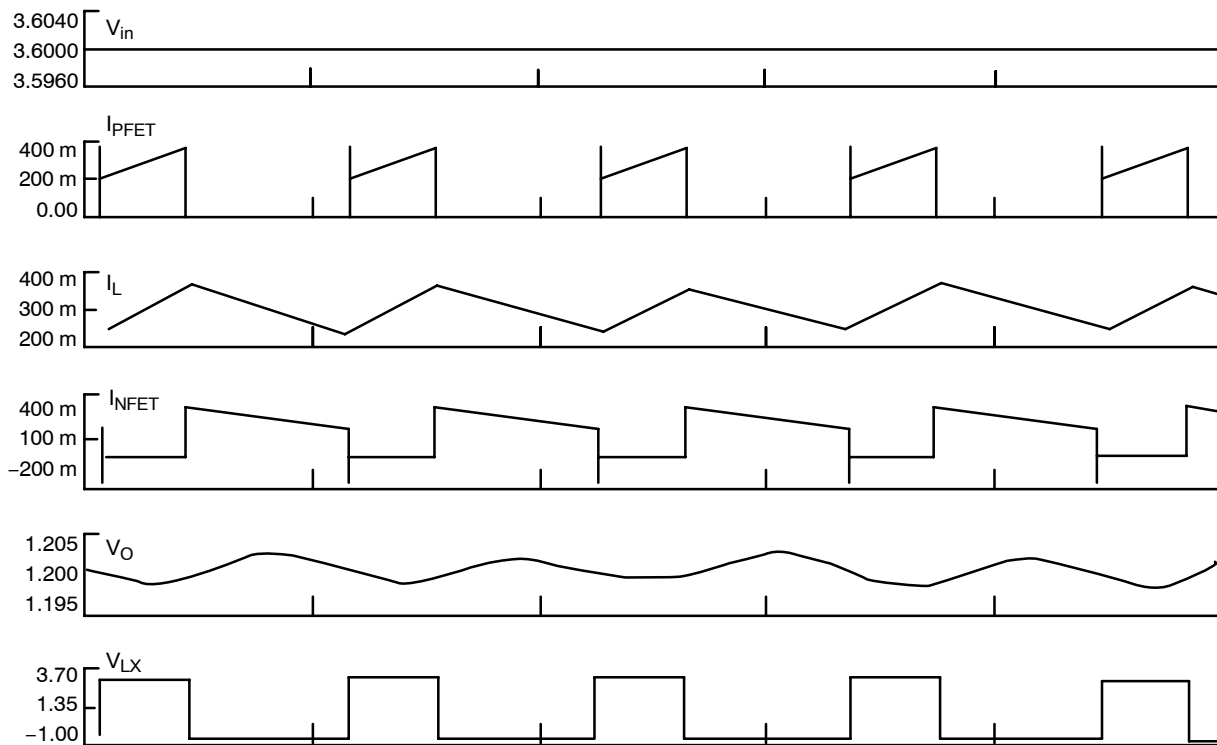

Figure 24. Waveforms During PWM Operation

Soft-Start

The NCP1526 uses soft-start to limit the inrush current when the device is initially powered up or enabled. Soft-start is implemented by gradually increasing the reference voltage until it reaches the full reference voltage. During startup, a pulsed current source charges the internal soft-start capacitor to provide gradually increasing reference voltage. When the voltage across the capacitor ramps up to the nominal reference voltage, the pulsed current source will be switched off and the reference voltage will switch to the regular reference voltage.

Cycle-by-Cycle Current Limitation

From the block diagram (Figure 2), an ILIM comparator is used to realize cycle-by-cycle current limit protection. The comparator compares the LX pin voltage with the reference voltage, which is biased by a constant current. If the inductor current reaches the limit, the ILIM comparator detects the LX voltage falling below the reference voltage and releases the signal to turn off the switch Q1. The cycle-by-cycle current limit is set at 1000 mA (nom).

Shutdown Mode

When the EN1 pin has a voltage applied of less than 0.4 V, the DC–DC converter block will be disabled. In shutdown mode, the internal reference, oscillator and most of the control circuitries are turned off. Therefore, the typical current consumption will be 0.2 μA (typical value). Applying a voltage above 1.2 V to EN1 pin will enable the DC–DC converter for normal operation. The device will go through soft–start to normal operation.

Thermal Shutdown

Internal Thermal Shutdown circuitry is provided to protect the integrated circuit in the event that the maximum junction temperature is exceeded. If the junction temperature exceeds 160°C, the device shuts down. In this mode switch Q1 and Q2 and the control circuits are all turned off. The device restarts in soft–start after the temperature drops below 135°C. This feature is provided to prevent catastrophic failures from accidental device overheating and it is not intended as a substitute for proper heatsinking.

Undervoltage Lockout

The input voltage VIN1 must reach 2.5 V (typ) before the NCP1526 enables the DC–DC converter output to begin the startup sequence (see soft–start section). The UVLO threshold hysteresis is typically 100 mV.

APPLICATION INFORMATION

Input Capacitor Selection

In PWM operating mode, the input current is pulsating with large switching noise. Using an input bypass capacitor can reduce the peak current transients drawn from the input supply source, thereby reducing switching noise significantly. The capacitance needed for the input bypass capacitor depends on the source impedance of the input supply.

The maximum RMS current occurs at 50% duty cycle with maximum output current, which is IO, max/2.

For NCP1526, a low profile ceramic capacitor of 4.7 μF should be used for most of the cases. For effective bypass results, the input capacitor should be placed as close as possible to the VIN Pin.

Table 1. List of Input Capacitors

Murata	GRM188R60J475KE
	GRM21BR71C475KA
Taiyo Yuden	JMK212BY475MG
TDK	C2012X5ROJ475KB
	C1632X5ROJ475KT

Output L–C filter Design Considerations:

The NCP1526 is built in 3 MHz frequency and uses voltage mode architecture. The correct selection of the output filter ensures good stability and fast transient response.

Due to the nature of the buck converter, the output L–C filter must be selected to work with internal compensation. For NCP1526, the internal compensation is internally fixed and it is optimized for an output filter of L = 2.2 μH and COUT = 4.7 μF

The corner frequency is given by:

$$f_c = \frac{1}{2\pi\sqrt{L \times C_{out}}} = \frac{1}{2\pi\sqrt{2.2 \mu H \times 4.7 \mu F}} = 49.5 \text{ KHz}$$

The device operates with inductance value between 1 μH and maximum of 4.7 μH.

If the corner frequency is moved, it is recommended to check the loop stability depending of the output ripple voltage accepted and output current required. For lower frequency, the stability will be increase; a larger output capacitor value could be chosen without critical effect on the system. On the other hand, a smaller capacitor value increases the corner frequency and it should be critical for the system stability. Take care to check the loop stability. The phase margin is usually higher than 45°.

Table 2. L–C Filter Example

Inductance (L)	Output Capacitor (Cout)
1 μH	10 μF
2.2 μH	4.7 μF
4.7 μH	2.2 μF

Inductor selection

The inductor parameters directly related to device performances are saturation current and DC resistance and inductance value. The inductor ripple current (ΔIL) decreases with higher inductance:

$$\Delta I_L = \frac{V_{out}}{L \times f_{sw}} \left(1 - \frac{V_{out}}{V_{in}} \right)$$

ΔIL peak to peak inductor ripple current

L inductor value

fsw Switching frequency

The Saturation current of the inductor should be rated higher than the maximum load current plus half the ripple current:

$$I_L(MAX) = I_O(MAX) + \frac{\Delta I_L}{2}$$

IL(MAX) Maximum inductor current

IO(MAX) Maximum Output current

The inductor’s resistance will factor into the overall efficiency of the converter. For best performances, the DC resistance should be less than 0.3 Ω for good efficiency.

Table 3. List of Inductors

FDK	MIPW3226 series
TDK	VLF3010AT series
Taiyo Yuden	LQ CBL2012
Coil craft	DO1605-T series
	LPO3008

Output capacitor selection

Selecting the proper output capacitor is based on the desired output ripple voltage. Ceramic capacitors with low ESR values will have the lowest output ripple voltage and are strongly recommended. The output capacitor requires either an X7R or X5R dielectric.

The output ripple voltage in PWM mode is given by:

$$\Delta V_{out} = \Delta I_L \times \left(\frac{1}{4 \times f_{sw} \times C_{out}} + ESR \right)$$

Table 4. List of Output Capacitors

Murata	GRM188R60J475KE	4.7 μ F
	GRM21BR71C475KA	
Taiyo Yuden	GRM188R60OJ106ME	10 μ F
	JMK212BY475MG	4.7 μ F
TDK	JMK212BJ106MG	10 μ F
	C2012X5ROJ475KB	4.7 μ F
	C1632X5ROJ475KT	
	C2012X5ROJ106K	10 μ F

OUTPUT VOLTAGE OPTIONS AVAILABLE UPON REQUEST

	DC/DC Converter
Fixed Output Voltage (V)	0.9
	1.0
	1.1
	1.2
	1.3
	1.4
	1.5
	1.6
	1.7
	1.8
	1.9
	2.5
	2.7
3.0	
3.3	

LDO Operation

Voltage Regulator V1

V1 is a 2.80 V, 3% low drop voltage regulator dedicated to RF sensitive module. It can deliver up to 150 mA and is totally protected against short to ground (current limitation) and overtemperature (thermal shutdown circuit with hysteresis).

The PSRR of the reference is in excess of 67 dB at 1.0 kHz. The output of the V1 requires a 1.0 μ F capacitor for stability. An additional 100 nF capacitor is necessary on the BYPASS pin for a low output noise. If the BYPASS pin is supporting an additional load, the stability and performance of the V1 will be diminished. Since the input voltage can go as low as 3.0 V, the reference output will be affected and can drop as low as 150 mV below the input voltage at 150 mA output current. During this low dropout, the PSRR of the reference is reduced. V1 is active when logic high is applied to the EN2 pin. It is turned off by a logic low on the EN2 pin.

Reference Bypass Capacitor Node (Bypass)

An optional 100 nF BYPASS capacitor creates a low pass filter for LDO noise reduction. The output voltage noise is 45 μ V_{RMS} with C_{BYPASS} = 0.1 μ F and C_{OUT} = 1.0 μ F. If the BYPASS pin is supporting an additional load, the stability and performance of the NCP1526 will be diminished.

Current Limiting

The output voltage regulator limits the output current to I_{SC} = 300 mA (typ). If the LDO output current exceeds I_{SC}, the output voltage drops.

Shutdown Mode

When the EN2 pin has a voltage applied of less than 0.4 V, the output voltage regulator will be disabled. In shutdown mode, the internal reference and most of the control circuitries are turned off. Therefore, the typical current consumption will be 0.2 μ A (typical value). Applying a voltage above 1.2 V to EN2 pin will enable the LDO for normal operation.

OUTPUT VOLTAGE OPTIONS AVAILABLE UPON REQUEST

	LDO
Fixed Output Voltage (V)	2.5
	2.6
	2.7
	2.8
	2.85
	3.0
	3.1
	3.3

APPLICATION BOARD

PCB Layout Recommendations

Good PCB layout plays an important role in switching mode power conversion. Careful PCB layout can help to minimize ground bounce, EMI noise and unwanted feedback that can affect the performance of the converter. Hints suggested below can be used as a guideline in most situations.

1. Use star-ground connection to connect the IC ground nodes and capacitor GND nodes together at one point. Keep them as close as possible, and then connect this to the ground plane through several vias. This will reduce noise in the ground plane by preventing the switching currents from flowing through the ground plane.

2. Place the power components (i.e., input capacitor, inductor and output capacitor) as close together as possible for best performance. All connecting traces must be short, direct, and wide to reduce voltage errors caused by resistive losses through the traces.
3. Separate the feedback path of the output voltage from the power path. Keep this path close to the NCP1526 circuit. And also route it away from noisy components. This will prevent noise from coupling into the voltage feedback trace.

The following shows the NCP1526 demo board schematic and layout and bill of materials:

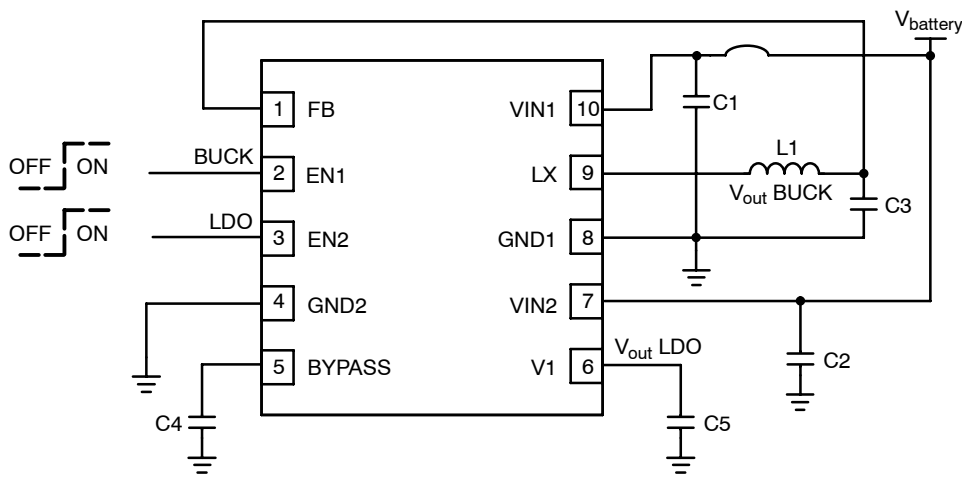

Figure 25. NCP1526 Board Schematic

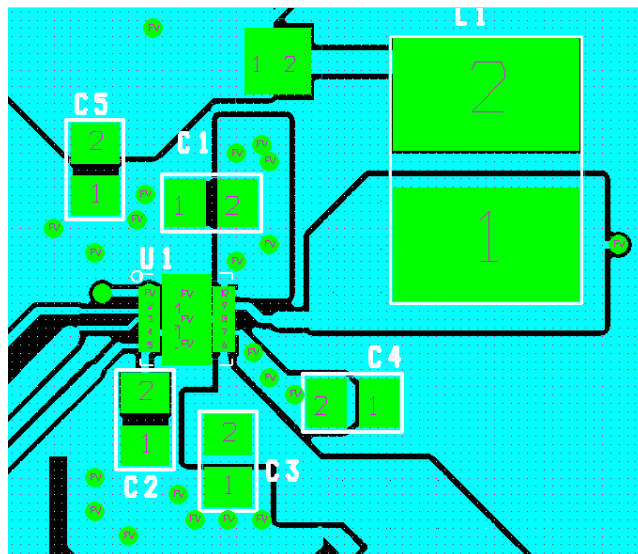

Figure 26. NCP1526 Board Layout

NCP1526

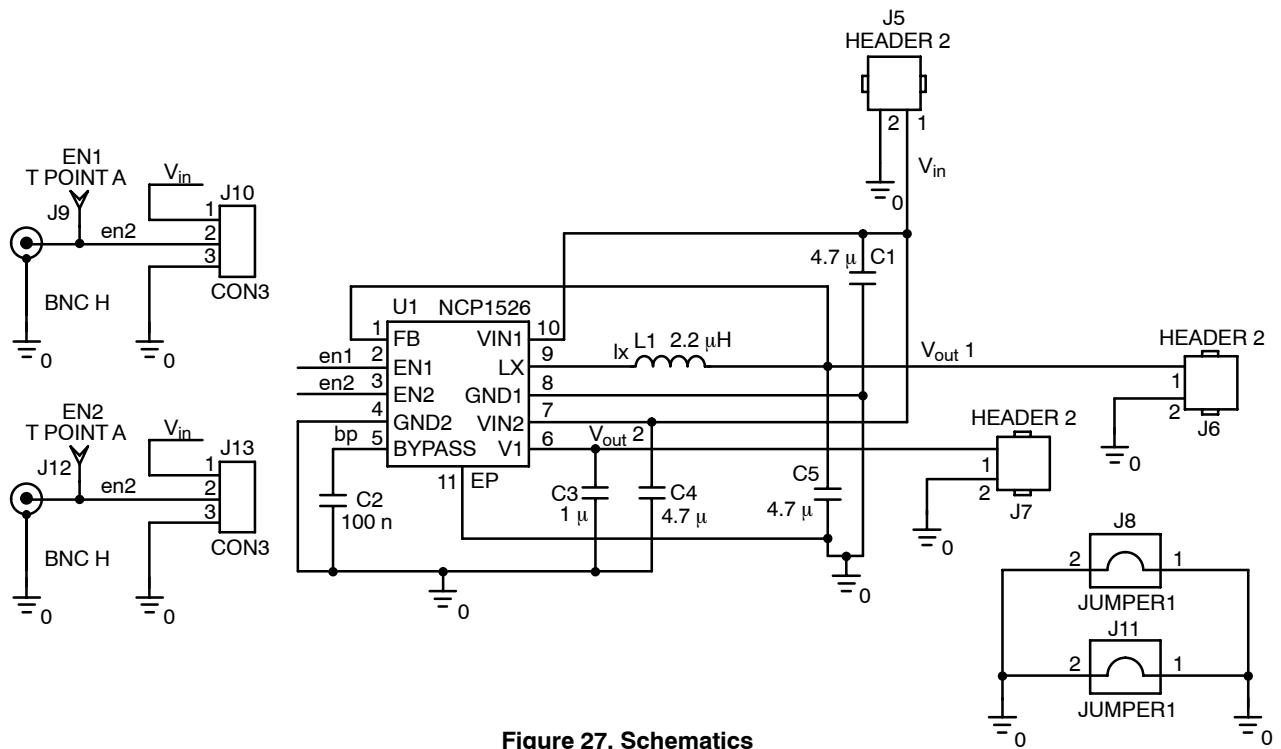

Figure 27. Schematics

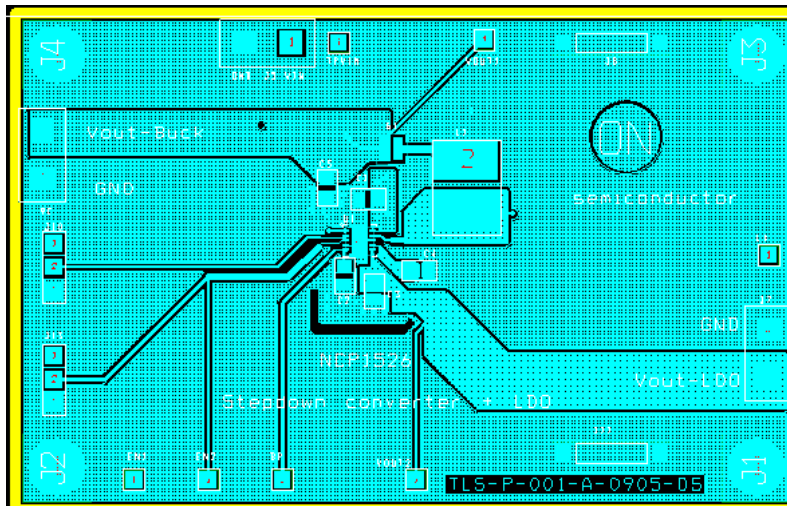

Figure 28. Board Layout (Top View)

NCP1526

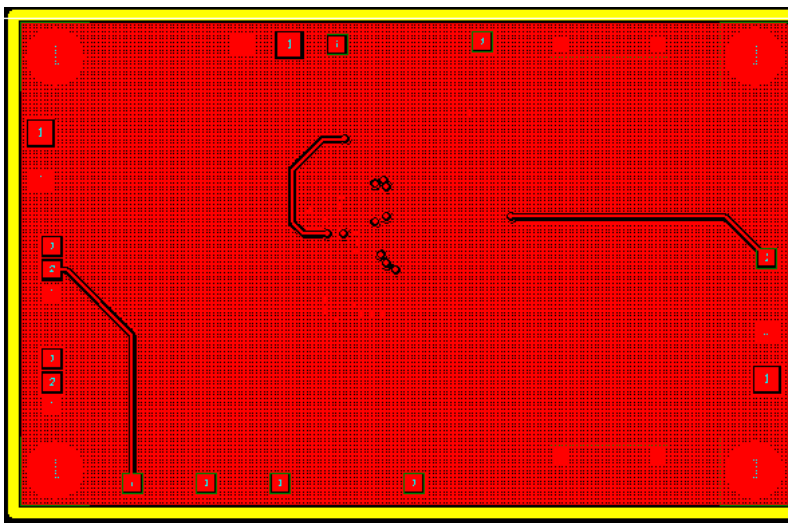

Figure 29. Board Layout (Bottom View)

Bill of Materials

Item	Part Description	Ref	PCB Footprint	Manufacturer	Manufacturer Reference
1	NCP1526	U1	UDFN	ON Semiconductor	NCP1526
2	4.7 μ F ceramic capacitor 6.3 V X5R	C1, C4, C5	0805	Murata	GRM21 series
3	1 μ F ceramic capacitor 6.3 V X5R	C3	0805	Murata	GRM21 series
4	100 nF ceramic capacitor 10 V X7R	C2	0805	Murata	GRM19 series
6	SMD Inductor	L1	1605	Coilcraft	DO1605 series
7	I/O connector, it can be plugged by BLZ5.08/2 (Weidmüller reference)	J5, J6, J7	-	Weidmüller	SL5.08/2/90B
8	Jumper Header vertical mount 3*1, 2.54 mm	J10, J13	-	Tyco electronics/AMP	5-826629-0
9	Jumper connector, 400 mils	J8, J11	-	Harwin	D3082-B01

NCP1526

PACKAGE DIMENSIONS

10 PIN UDFN
CASE 506AT-01
ISSUE O

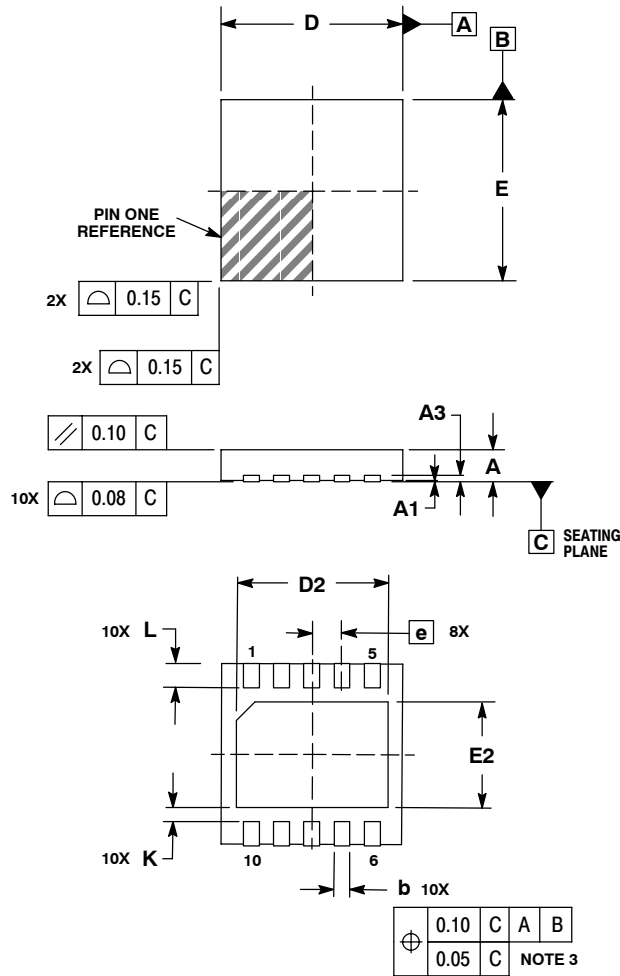

NOTES:

1. DIMENSIONING AND TOLERANCING PER ASME Y14.5M, 1994.
2. CONTROLLING DIMENSION: MILLIMETERS.
3. DIMENSION b APPLIES TO PLATED TERMINAL AND IS MEASURED BETWEEN 0.25 AND 0.30mm FROM TERMINAL.
4. COPLANARITY APPLIES TO THE EXPOSED PAD AS WELL AS THE TERMINALS.

DIM	MILLIMETERS		
	MIN	NOM	MAX
A	0.45	0.50	0.55
A1	0.00	0.03	0.05
A3	0.127 REF		
b	0.18	0.25	0.30
D	3.00 BSC		
D2	2.40	2.50	2.60
E	3.00 BSC		
E2	1.70	1.80	1.90
e	0.50 BSC		
K	0.19 TYP		
L	0.30	0.40	0.50

SOLDERING FOOTPRINT*

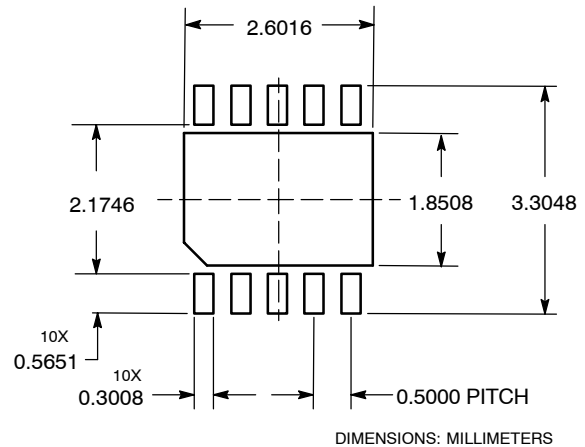

*For additional information on our Pb-Free strategy and soldering details, please download the ON Semiconductor Soldering and Mounting Techniques Reference Manual, SOLDERRM/D.

ON Semiconductor and are registered trademarks of Semiconductor Components Industries, LLC (SCILLC). SCILLC reserves the right to make changes without further notice to any products herein. SCILLC makes no warranty, representation or guarantee regarding the suitability of its products for any particular purpose, nor does SCILLC assume any liability arising out of the application or use of any product or circuit, and specifically disclaims any and all liability, including without limitation special, consequential or incidental damages. "Typical" parameters which may be provided in SCILLC data sheets and/or specifications can and do vary in different applications and actual performance may vary over time. All operating parameters, including "Typicals" must be validated for each customer application by customer's technical experts. SCILLC does not convey any license under its patent rights nor the rights of others. SCILLC products are not designed, intended, or authorized for use as components in systems intended for surgical implant into the body, or other applications intended to support or sustain life, or for any other application in which the failure of the SCILLC product could create a situation where personal injury or death may occur. Should Buyer purchase or use SCILLC products for any such unintended or unauthorized application, Buyer shall indemnify and hold SCILLC and its officers, employees, subsidiaries, affiliates, and distributors harmless against all claims, costs, damages, and expenses, and reasonable attorney fees arising out of, directly or indirectly, any claim of personal injury or death associated with such unintended or unauthorized use, even if such claim alleges that SCILLC was negligent regarding the design or manufacture of the part. SCILLC is an Equal Opportunity/Affirmative Action Employer. This literature is subject to all applicable copyright laws and is not for resale in any manner.

PUBLICATION ORDERING INFORMATION

LITERATURE FULFILLMENT:
Literature Distribution Center for ON Semiconductor
P.O. Box 5163, Denver, Colorado 80217 USA
Phone: 303-675-2175 or 800-344-3860 Toll Free USA/Canada
Fax: 303-675-2176 or 800-344-3867 Toll Free USA/Canada
Email: orderlit@onsemi.com

N. American Technical Support: 800-282-9855 Toll Free
USA/Canada
Europe, Middle East and Africa Technical Support:
Phone: 421 33 790 2910
Japan Customer Focus Center
Phone: 81-3-5773-3850

ON Semiconductor Website: www.onsemi.com
Order Literature: <http://www.onsemi.com/orderlit>

For additional information, please contact your local Sales Representative